

1064_0 Mechanical Drawing

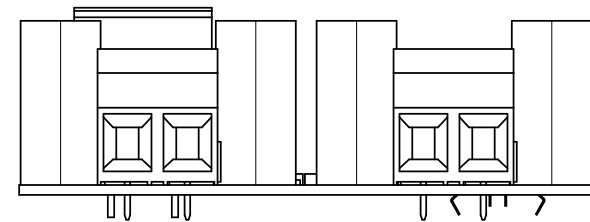
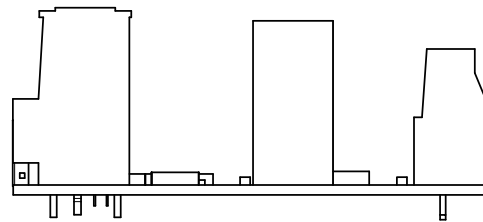
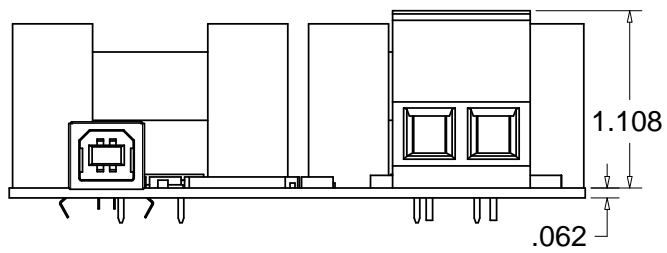
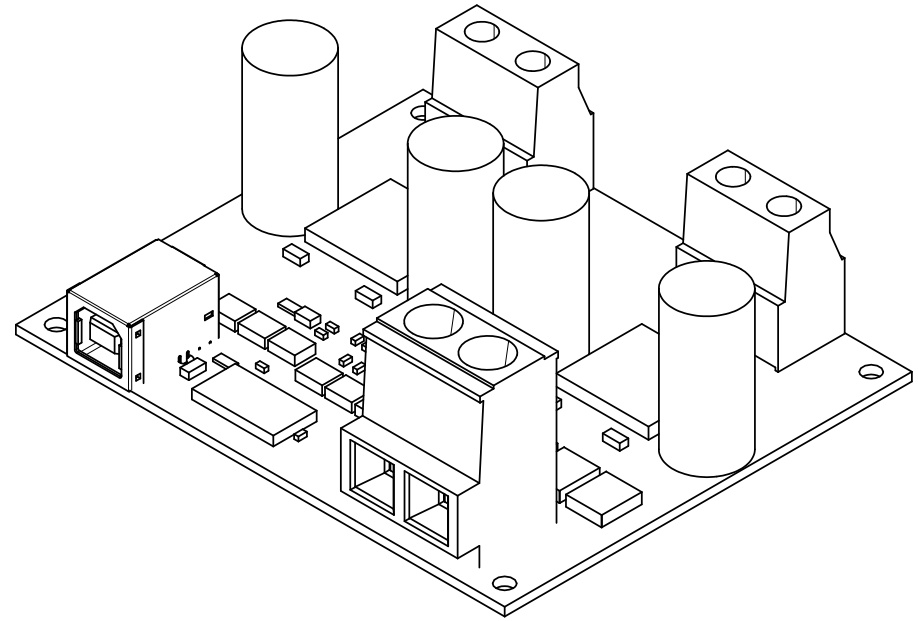
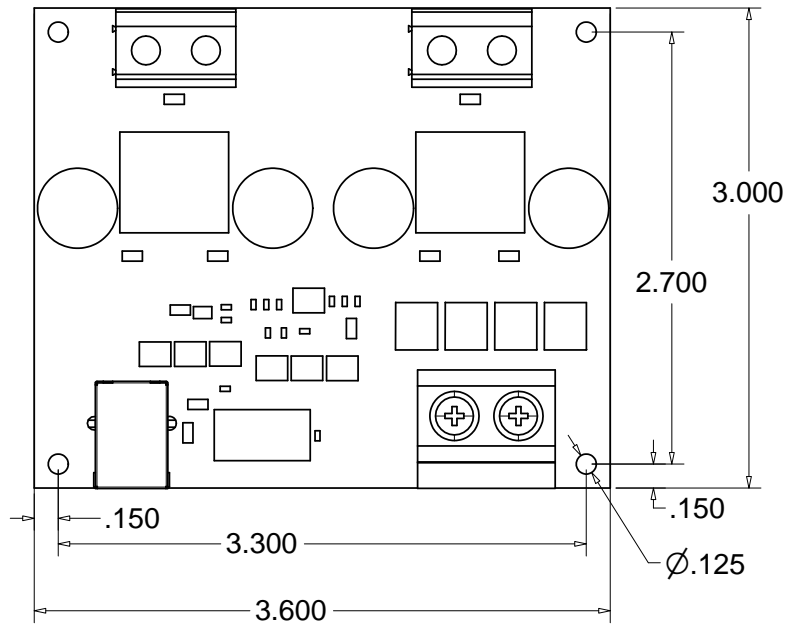

Scale 1:1.2
Units are in Inches